

## EP 145

96269187 EP 145 LED 36L70 SC 740 RS/MTP

THORN

### EP 145

A 19th Century styled post top lantern with 36 LEDs driven at 700mA with Street & Comfort optic. Class II electrical, IP66, IK08. Body: stainless steel, painted black (close to RAL9005). Canopy: GRP/Polyester, black (close to RAL9005) finish. Enclosure: 5mm thick tempered glass. Complete with 4000K LED

Dimensions: 420 x 420 x 767 mm

Luminaire input power: 77 W

Weight: 8.6 kg

Scx: 0.145 m<sup>2</sup>



TLG\_EP14\_F\_LEDMPBLKPDB.jpg

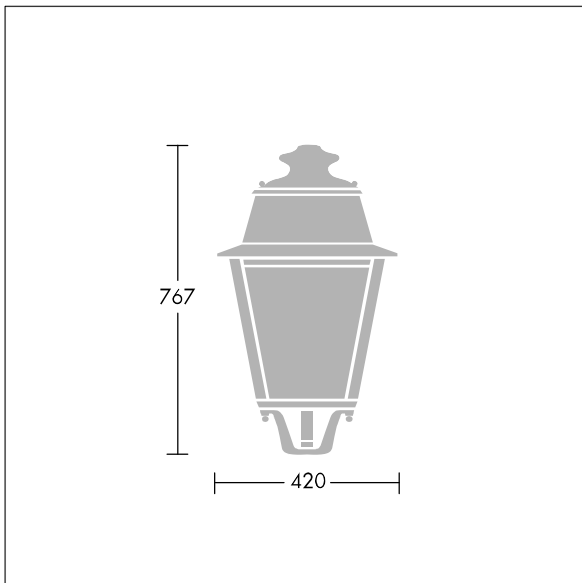

TLG\_EPLS\_M\_LD1.wmf

This product contains a light source of energy efficiency class D.

All values marked with an \* are rated values. Thorn uses tried and tested components from leading suppliers, however there may be isolated instances of technology-related failures of individual LEDs during the rated product lifetime. International standards set the tolerance in initial flux and connected load at  $\pm 10\%$ . Unless stated otherwise, the values apply to an ambient temperature of 25°C.

Thorn Lighting is constantly developing and improving its products. The right is reserved to change specifications without prior notification or public announcement.  
© Thorn Lighting

**EP 145**

**96269187 EP 145 LED 36L70 SC 740 RS/MTP**

**THORN**