

## EP 145

96269228 EP 145 LED 24L35 BP NR 740 RCU/MSU

THORN

### EP 145

A 19th Century styled suspended lantern with 24 LEDs driven at 350mA with Narrow Road optic. Integral power reduction function which dims down to 50% power, effective 3 hours before and 5 hours after a calculated midnight. Class II electrical, IP66, IK08. Body: copper, treated. Canopy: GRP/Polyester, copper finish. Enclosure: 5mm thick tempered glass. Complete with 4000K LED

Dimensions: 420 x 420 x 944 mm

Luminaire input power: 28 W

Weight: 11.8 kg

Scx: 0.145 m<sup>2</sup>



TLG\_EP14\_F\_LEDMSUCOPPDB.jpg

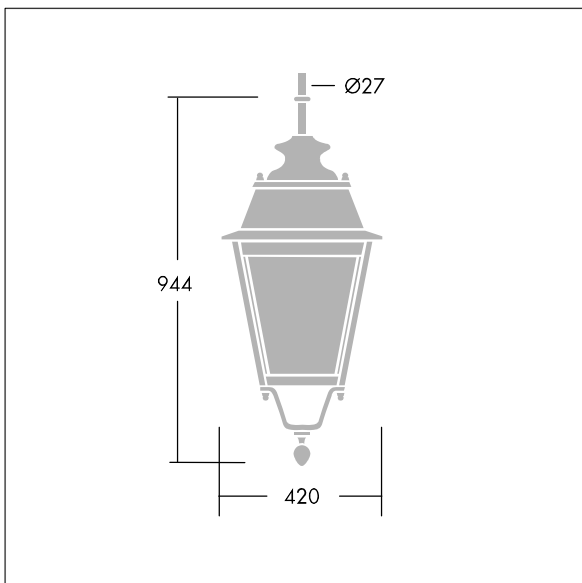

TLG\_EPLS\_M\_LD2.wmf

This product contains a light source of energy efficiency class D.

All values marked with an \* are rated values. Thorn uses tried and tested components from leading suppliers, however there may be isolated instances of technology-related failures of individual LEDs during the rated product lifetime. International standards set the tolerance in initial flux and connected load at  $\pm 10\%$ . Unless stated otherwise, the values apply to an ambient temperature of 25°C.

Thorn Lighting is constantly developing and improving its products. The right is reserved to change specifications without prior notification or public announcement.  
© Thorn Lighting

**EP 145**

**96269228 EP 145 LED 24L35 BP NR 740 RCU/MSU**

**THORN**