

Areaflood Pro

96644814 AFP S 36L50-740 WR HFX CL2 GY

THORN

Areaflood Pro

A compact, lightweight, general purpose LED area floodlight. With small body. LED converter configured for DALI control over additional wires, driving 36 LEDs at 500mA with Wide Road light distribution. IP66, IK08, Class II electrical. Body: die-cast aluminium (EN AC-44300), Light grey 150 sanded textured (close to RAL9006).. Enclosure: 4mm thick toughened glass. Reversible mounting stirrup supplied, Complete with 4000K LED.

Dimensions: 462 x 265 x 139 mm
Luminaire input power: 55 W
Luminaire luminous flux: 8698 lm
Luminaire efficacy: 158 lm/W
weight: 6.23 kg
Scx: 0.05 m²



TLG_AFLP_F_SMALLPDB.jpg

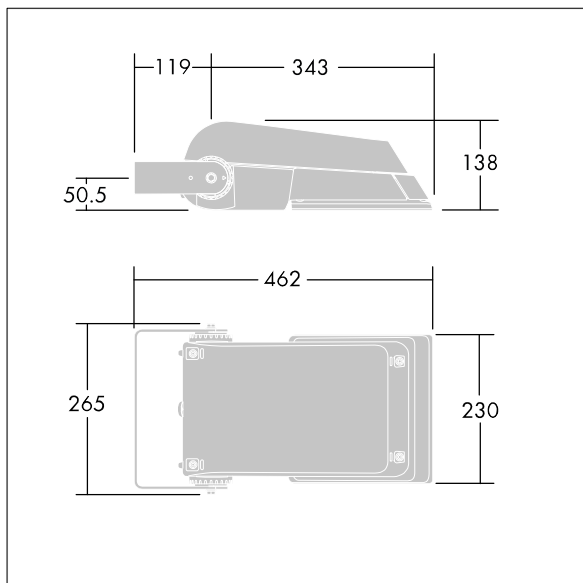

TLG_AFLP_M_SML.wmf

This product contains light sources of energy efficiency class E.

All values marked with an * are rated values. Thorn uses tried and tested components from leading suppliers, however there may be isolated instances of technology-related failures of individual LEDs during the rated product lifetime. International standards set the tolerance in initial flux and connected load at $\pm 10\%$. Unless stated otherwise, the values apply to an ambient temperature of 25°C.

Thorn Lighting is constantly developing and improving its products. The right is reserved to change specifications without prior notification or public announcement.
© Thorn Lighting

Areaflood Pro

96644814 AFP S 36L50-740 WR HFX CL2 GY

THORN