

Areaflood Pro

96644818 AFP S 36L50-740 EWR HFX CL1 GY

Areaflood Pro

A compact, lightweight, general purpose LED area floodlight. With small body. LED converter configured for DALI control over additional wires, driving 36 LEDs at 500mA with Extra Wide Road light distribution. IP66, IK08, Class I electrical. Body: die-cast aluminium (EN AC-44300), Light grey 150 sanded textured (close to RAL9006).. Enclosure: 4mm thick toughened glass. Reversible mounting stirrup supplied, Complete with 4000K LED.

Dimensions: 462 x 265 x 139 mm
 Luminaire input power: 55 W
 Luminaire luminous flux: 8651 lm
 Luminaire efficacy: 157 lm/W
 weight: 6.2 kg
 Scx: 0.05 m²



TLG_AFLP_F_SMALLPDB.jpg

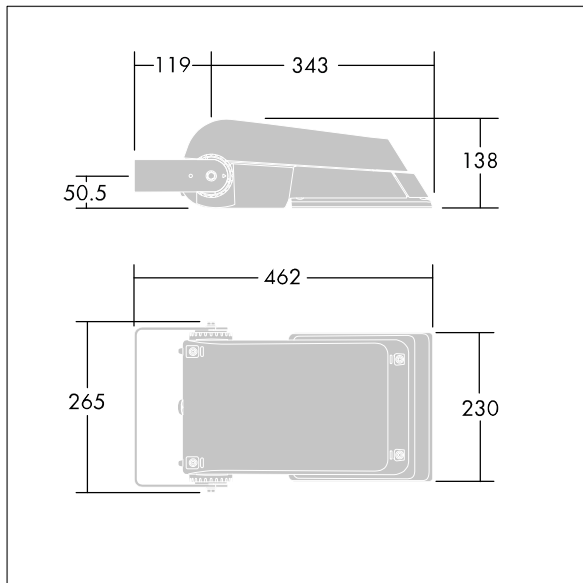

TLG_AFLP_M_SML.wmf

This product contains light sources of energy efficiency class E.

Areaflood Pro

96644818 AFP S 36L50-740 EWR HFX CL1 GY

THORN