

# Areaflood Pro

96644850 AFP S 36L70-740 A6 HFX CL2 GY

THORN

## Areaflood Pro

A compact, lightweight, general purpose LED area floodlight. With small body, LED converter configured for DALI control over additional wires, driving 36 LEDs at 700mA with asymmetrical 60° light distribution. IP66, IK08, Class II electrical. Body: die-cast aluminium (EN AC-44300), Light grey 150 sanded textured (close to RAL9006).. Enclosure: 4mm thick toughened glass. Reversible mounting stirrup supplied, Complete with 4000K LED.

Dimensions: 462 x 265 x 139 mm  
Luminaire input power: 77 W  
Luminaire luminous flux: 11426 lm  
Luminaire efficacy: 148 lm/W  
weight: 6.29 kg  
Scx: 0.05 m<sup>2</sup>



TLG\_AFLP\_F\_SMALLPDB.jpg

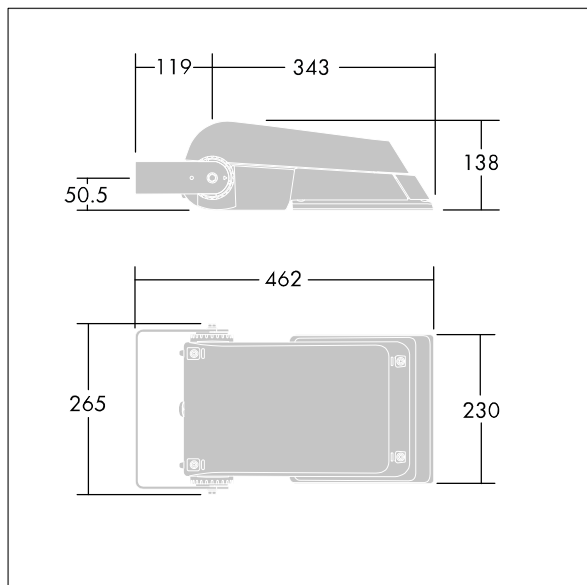

TLG\_AFLP\_M\_SML.wmf

This product contains light sources of energy efficiency class E.

All values marked with an \* are rated values. Thorn uses tried and tested components from leading suppliers, however there may be isolated instances of technology-related failures of individual LEDs during the rated product lifetime. International standards set the tolerance in initial flux and connected load at  $\pm 10\%$ . Unless stated otherwise, the values apply to an ambient temperature of 25°C.

Thorn Lighting is constantly developing and improving its products. The right is reserved to change specifications without prior notification or public announcement.  
© Thorn Lighting