

# EyeKon LED

96665961 EYE BE LED1550-830 HF L ANT

THORN

## EyeKon LED

Round, impact resistant LED bulkhead luminaire.  
Electronic, fixed output control gear. Class I electrical, IP65, IK10. Body: large size, die-cast aluminium (LM6), powder coated anthracite. Diffuser: opal polycarbonate with die-cast aluminium bezel feature. Electrical connection via 3 x 2 x 2.5mm<sup>2</sup> terminal block. Complete with 3000K LED

Dimensions: Ø340 x 155 mm

Luminaire input power: 16 W

Weight: 3.3 kg



TLG\_EYKN\_F\_LGBEZANTHOP.jpg

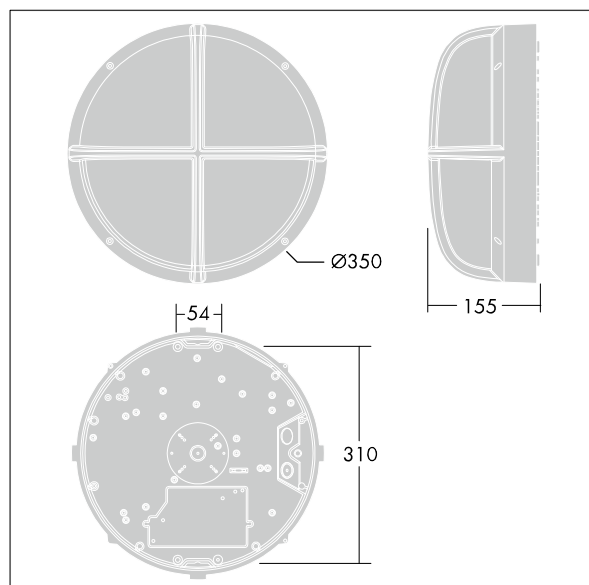

TLG\_EYKN\_M\_LGE.wmf

This product contains a light source of energy efficiency class C.

All values marked with an \* are rated values. Thorn uses tried and tested components from leading suppliers, however there may be isolated instances of technology-related failures of individual LEDs during the rated product lifetime. International standards set the tolerance in initial flux and connected load at  $\pm 10\%$ . Unless stated otherwise, the values apply to an ambient temperature of 25°C.

Thorn Lighting is constantly developing and improving its products. The right is reserved to change specifications without prior notification or public announcement.  
© Thorn Lighting

**EyeKon LED**

**96665961 EYE BE LED1550-830 HF L ANT**

**THORN**