

# EyeKon LED

96666064 EYE VS LED750-830 COR MWS E3TX L ANT

THORN

## EyeKon LED

Round, impact resistant LED bulkhead luminaire.  
Electronic, fixed output control gear with 3 hour, Self/DALI  
Addressable test, emergency lighting circuit. Class I  
electrical, IP65, IK10. Body: large size, die-cast aluminium  
(LM6), powder coated anthracite. Diffuser: opal  
polycarbonate with die-cast aluminium visor feature.  
Electrical connection via 6 x 2 x 2.5mm<sup>2</sup> terminal block.  
With integral motion sensor for corridor function control  
(master). Complete with 3000K LED

Dimensions: Ø340 x 155 mm

Luminaire input power: 11 W

Weight: 3.48 kg



TLG\_EYKN\_F\_LGVSANTHOP.jpg

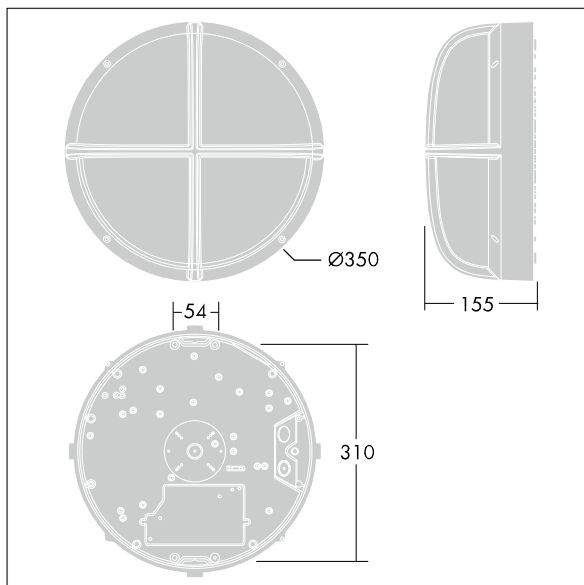

TLG\_EYKN\_M\_LGE.wmf

This product contains a light source of energy efficiency class C.

All values marked with an \* are rated values. Thorn uses tried and tested components from leading suppliers, however there may be isolated instances of technology-related failures of individual LEDs during the rated product lifetime. International standards set the tolerance in initial flux and connected load at  $\pm 10\%$ . Unless stated otherwise, the values apply to an ambient temperature of 25°C.

Thorn Lighting is constantly developing and improving its products. The right is reserved to change specifications without prior notification or public announcement.  
© Thorn Lighting