

EyeKon LED

96666062 EYE VS LED750-830 MWS E3TX L ANT

THORN

EyeKon LED

Round, impact resistant LED bulkhead luminaire.
Electronic, fixed output control gear with 3 hour, Self/DALI
Addressable test, emergency lighting circuit. Class I
electrical, IP65, IK10. Body: large size, die-cast aluminium
(LM6), powder coated anthracite. Diffuser: opal
polycarbonate with die-cast aluminium visor feature.
Electrical connection via 6 x 2 x 2.5mm² terminal block.
With integral motion sensor for on/off control. Complete
with 3000K LED

Dimensions: Ø340 x 155 mm

Luminaire input power: 11 W

Weight: 3.46 kg



TLG_EYKN_F_LGVSANTHOP.jpg

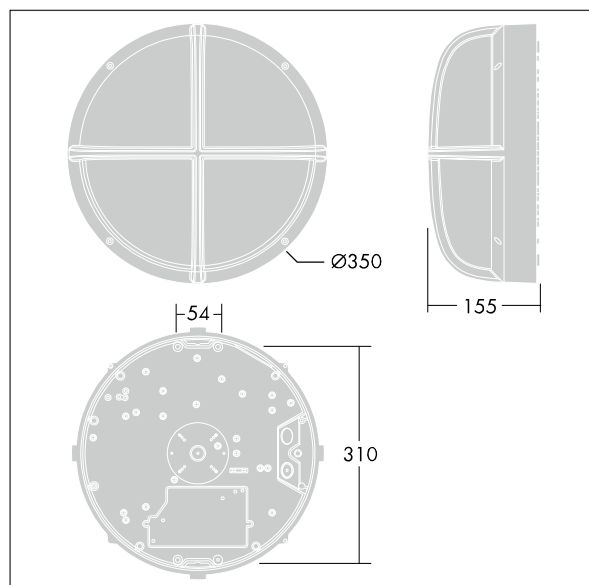

TLG_EYKN_M_LGE.wmf

This product contains a light source of energy efficiency class C.

All values marked with an * are rated values. Thorn uses tried and tested components from leading suppliers, however there may be isolated instances of technology-related failures of individual LEDs during the rated product lifetime. International standards set the tolerance in initial flux and connected load at $\pm 10\%$. Unless stated otherwise, the values apply to an ambient temperature of 25°C.

Thorn Lighting is constantly developing and improving its products. The right is reserved to change specifications without prior notification or public announcement.
© Thorn Lighting

EyeKon LED

96666062 EYE VS LED750-830 MWS E3TX L ANT

THORN