

CiviTEQ

96665738 CQ XL 120L50-740 WS BPS CLO CL1 M76

THORN

CiviTEQ

A size LED road lighting lantern with 120 LEDs driven at 500mA with Wide Street optic. Electronic, fixed output control gear. Class I electrical, IP66, IK08. Housing: die-cast aluminium, Light grey 150 sanded textured (close to RAL9006). Enclosure: toughened flat glass. Screws: stainless steel, Ecolubric® treated. Supplied with Ø76mm spigot adaptor which can be fitted for post-top (0°/5°/10° tilt) or side-entry (-20°/-15°/-10°/-5°/0° tilt). Driver programmed for constant light output. Complete with 4000K LED. Surge protection: 10kV single pulse common mode and 8kV multipulse common mode and 6kV multipulse differential mode. If permanent DALI system is connected, 6kV multipulse common and differential mode.

Dimensions: 761 x 490 x 139 mm

Luminaire input power: 177 W

Luminaire luminous flux: 28443 lm

Luminaire efficacy: 161 lm/W

Weight: 20.1 kg

Scx: 0.063 m²



TLG_CTEQ_F_XL.jpg

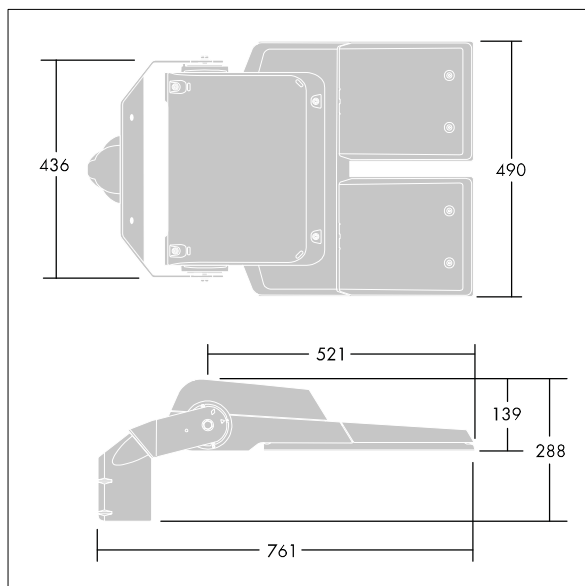

TLG_CETQ_M_CQ XL.wmf

This product contains light sources of energy efficiency classes D, E.

All values marked with an * are rated values. Thorn uses tried and tested components from leading suppliers, however there may be isolated instances of technology-related failures of individual LEDs during the rated product lifetime. International standards set the tolerance in initial flux and connected load at ±10%. Unless stated otherwise, the values apply to an ambient temperature of 25°C.

Thorn Lighting is constantly developing and improving its products. The right is reserved to change specifications without prior notification or public announcement.
© Thorn Lighting

CiviTEQ

96665738 CQ XL 120L50-740 WS BPS CLO CL1 M76

THORN