

PopPack

96631570 POPPACK LED 11000-840 HF L1800

THORN

PopPack

Batten LED luminaire. Electronic, fixed output control gear.
Body: coated, formed steel, white (RAL9016). End caps:
injection moulded polycarbonate,. Diffuser: textured opal
acrylic. Electrical connection via 3 x 2 x 2.5mm² terminal
block. Complete with 4000K LED

Dimensions: 1728 x 60 x 74 mm
Luminaire input power: 74.1 W
Luminaire luminous flux: 10900 lm
Luminaire efficacy: 147 lm/W
Weight: 1.8 kg



TLG_POPL_F_PDB_EMPTY.jpg

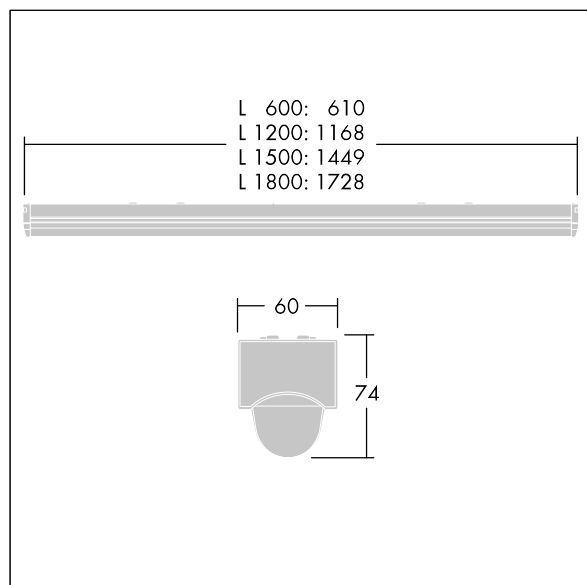

TLG_POPL_M_LD1.wmf

This product contains a light source of energy efficiency class D.

All values marked with an * are rated values. Thorn uses tried and tested components from leading suppliers, however there may be isolated instances of technology-related failures of individual LEDs during the rated product lifetime. International standards set the tolerance in initial flux and connected load at $\pm 10\%$. Unless stated otherwise, the values apply to an ambient temperature of 25°C.

Thorn Lighting is constantly developing and improving its products. The right is reserved to change specifications without prior notification or public announcement.
© Thorn Lighting

PopPack

96631570 POPPACK LED 11000-840 HF L1800

THORN