

Altis Gen5

96671928 ALG5 GB 2052W 0.70A 565V 3CH DA

THORN

Altis Gen5

Class I, DALI 2 programmable gearbox, with 3 independent output channels and IP66 enclosure, for TV broadcasting applications. Suitable for dedicated 432 / 456 / 480 / 504 LED Altis floodlight, to be installed remotely up to 200m from the floodlight. Nominal input voltage: 200-440, output current 700mA with DALI 2 configurable single-channel, IEEE 1789 flicker recommended practice compliant suitable for super slow motion camera filming, surge level 10kV for both common mode and differential.

Connection from mains via terminal blocks. Mains supply must be fused according to local safety regulations.

Weight: 6.2 kg.



TLG_ALT5_F_GB_1700.jpg

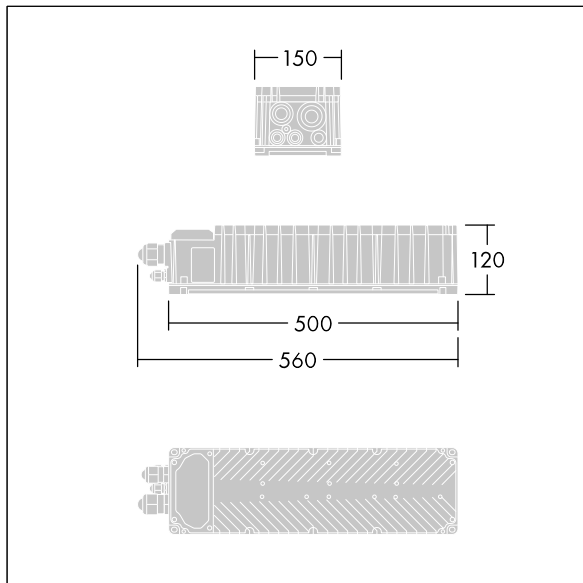

TLG_ALT5_M_GB.wmf