

Altis Gen5

96671932 ALG5 GB 1368W 0.85A 565V 2CH DA

THORN

Altis Gen5

Class I, DALI 2 programmable gearbox, with 2 independent output channels and IP66 enclosure, for TV broadcasting applications. Suitable for dedicated 288 / 312 / 336 LED Altis floodlight, to be installed remotely up to 200m from the floodlight. Nominal input voltage: 200-440, output current 850mA with DALI 2 configurable single-channel, IEEE 1789 flicker recommended practice compliant suitable for super slow motion camera filming, surge level 10kV for both common mode and differential.

Connection from mains via terminal blocks. Mains supply must be fused according to local safety regulations.

Weight: 5.4 kg.



TLG_ALT5_F_GB_1700.jpg

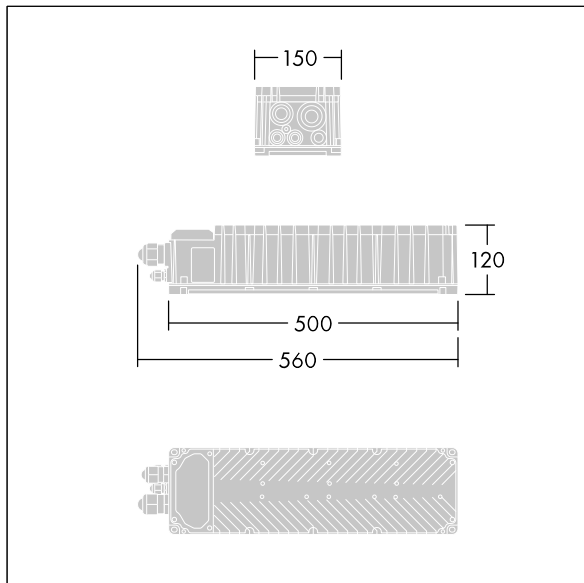

TLG_ALT5_M_GB.wmf