

# Urba Deco

96277184 UD 48L35 730 WSC-S CL1 WS1 T60T BK

THORN

## Urba Deco

A smart, sophisticated architectural urban lantern with 48 LEDs driven at 350mA and a Wide Street Comfort (symmetrical) optic. Electronic, fixed output control gear. Class I electrical, IP66, Impact strength: IK10. Canopy and base: die-cast aluminium (AS9U3, LM24 equivalent, EN AC-46000) textured black (close to RAL9005). Enclosure: 6mm thick clear glass. Arms: die-cast aluminium textured black (close to RAL9005) covered with a shield in plastic ASA. Pre-wired with 1m cable. Post top mounting to Ø60mm column, luminaire perpendicular to the road. Complete with 3000K LED.

Surge protection: 10kV single pulse common mode and 8kV multipulse common mode and 6kV multipulse differential mode. If permanent DALI system is connected, 6kV multipulse common and differential mode.

Dimensions: 510 x 241 x 474 mm  
Luminaire input power: 49.1 W  
Luminaire luminous flux: 7532 lm  
Luminaire efficacy: 153 lm/W  
Weight: 7.29 kg  
Scx: 0.049 m<sup>2</sup>



TLG\_URBD\_F\_MTPPDB.jpg

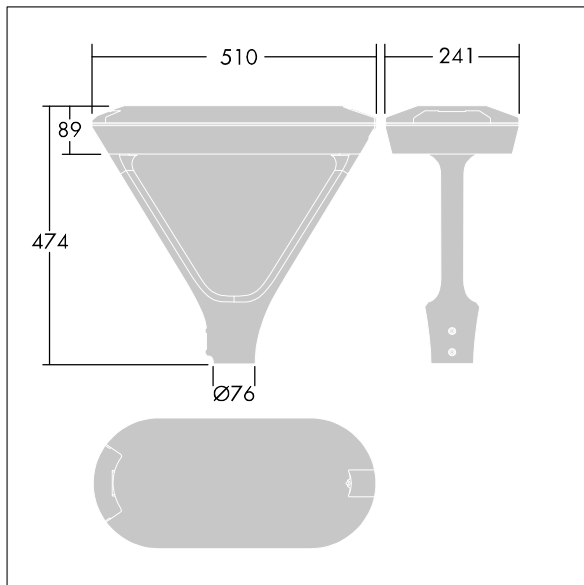

TLG\_URBD\_M\_MTP.wmf

This product contains a light source of energy efficiency class D.

All values marked with an \* are rated values. Thorn uses tried and tested components from leading suppliers, however there may be isolated instances of technology-related failures of individual LEDs during the rated product lifetime. International standards set the tolerance in initial flux and connected load at  $\pm 10\%$ . Unless stated otherwise, the values apply to an ambient temperature of 25°C.

Thorn Lighting is constantly developing and improving its products. The right is reserved to change specifications without prior notification or public announcement.  
© Thorn Lighting