

# Contus

96635827 CONTUS T L1500 WH

THORN

## Contus

Roll-formed sheet steel trunking units powder coated with white polyester lacquer. 5 mains power lines (5 x 2.5mm<sup>2</sup>/16A) plus 2 x 2 conductors (4 x 1.5mm<sup>2</sup>/10A) for integrating emergency lighting using two independently isolated circuits, plus and 2 control-line conductors (2 x 1.5mm<sup>2</sup>/10A). Tool-free connection using electrical feed kit.

Dimensions: 1520 x 60 x 58 mm

Weight: 2.9 kg

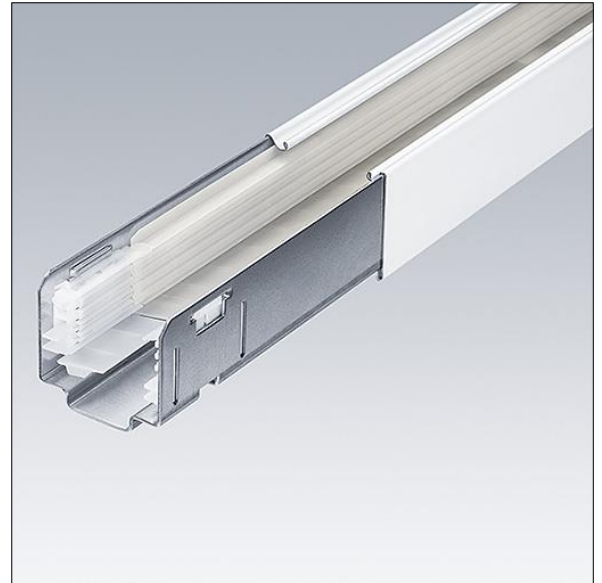

TLG\_CONT\_F\_TRUNKING2.jpg

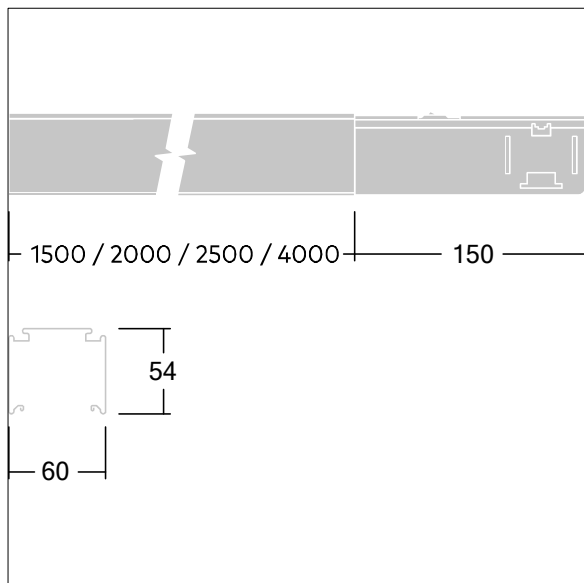

TL\_CONTUS\_M\_Trunking.wmf

All values marked with an \* are rated values. Unless stated otherwise, the values apply to an ambient temperature of 25°C.

Thorn Lighting is constantly developing and improving its products. The right is reserved to change specifications without prior notification or public announcement.  
© Thorn Lighting