

member of zumtobel group



Outdoor Lighting

2017 / 2018

THORN

Thorn – the performance brand for international volume business

Thorn is a reliable and globally recognised provider of lighting solutions for external and internal lighting with integrated control. The Thorn brand stands for powerful, efficient, reliable and operator-friendly lighting solutions with high quality light. Thorn sells luminaires and lighting solutions worldwide to an extensive group of customers from wholesalers, electrical contractors and specifiers to public and private end users.

Thorn provides lighting solutions in a wide range of application areas such as roads, tunnels, urban areas, offices, industry, education and sport. It is Thorn's goal to surpass the expectations of its customers worldwide and be a reliable, professional and long-term partner for cost-effective lighting solutions.



Contents

STREET LUMINAIRES



CiviTEQ
4

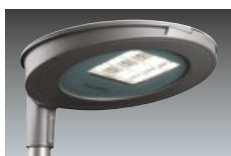

Dyana LED
6



Orus LED
8



R2L2
10



Thor
12



Urba
14

CITY AND PARK LUMINAIRES



Alumet Stage
16
Alumet Control
Direct
18



Avenue D² LED
20



Avenue F² LED
22



EP 145 LED
24



FleXity
26



Gamma LED
28



Legend
30

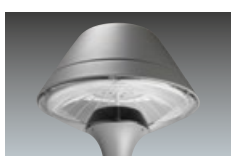

Plurio LED
32



Urba Deco
34

CITY AND PARK LUMINAIRES



Thor
LED bollard
37

AREA AND SPORTS FACILITY LIGHTING



Altis Area
38



Altis Sport
39



Areaflood Pro
40

TECHNICAL INFORMATION

Control options
42

Light distribution
43

Configuration instructions
44

CiviTEQ

Small Family of two LED luminaires for efficient, economical and future-oriented street lighting.



Technical data

Rated luminous flux:

- CiviTEQ S: 1807–9666 lm
- CiviTEQ L: 7218–19,133 lm

Rated output:

- CiviTEQ S: 14–79 W
- CiviTEQ L: 51–152 W

Light colours:

- 3000 K and 4000 K

Service life:

- 100,000 hours @ Ta 25 °C L90/B10

Light distribution options:

- 12 different THORN R-PEC LED light distribution options



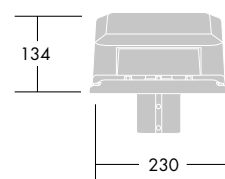
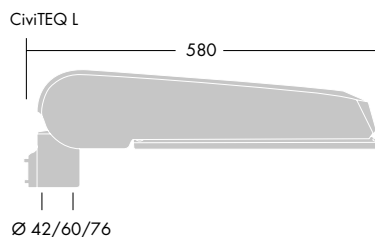
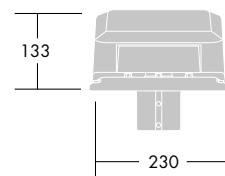
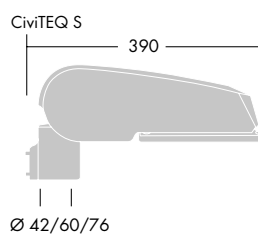

Material / Model

- Housing and column-top made from diecast aluminium, powder coated in THORN DARK GREY, structured (similar to DB 703 / AKZO 900)
- Tool-less access to equipment compartment via a stainless steel clip
- Cover made from flat safety glass, clear
- Screws made from stainless steel

Accessories

- Anti-glare louvre for house and road side
- Column flange for different column diameters
- Adapter for tilt adjustment up to -45°
- Integration of various sensors and smart lighting components

Installation / Assembly

- Suitable for column-top mounting and side-entry mounting for optional spigot size $\varnothing 76$ mm, $\varnothing 60$ mm or $\varnothing 42$ mm
- Variable tilt adjustment in 5° steps from 0° to $+10^\circ$ with column-top mounting and from -20° to 0° with side-entry mounting
- Delivery including column flange for optional $\varnothing 76$ mm, $\varnothing 60$ mm or $\varnothing 42$ mm column spigot

Dyana LED

High-quality family of luminaires in timelessly modern design for enhancing streets, pavements and squares.



Technical data

Rated luminous flux:

- Dyana S : 2945–11,490 lm
- Dyana L : 8734–17,000 lm

Rated output:

- Dyana S : 28–114 W
- Dyana L : 72–158 W

Light colours:

- 3000 K and 4000 K

Service life:

- 100,000 hours @ Ta 25 °C L90/B10

Light distribution options:

- 12 different THORN R-PEC
LED light distribution options





Dyana S

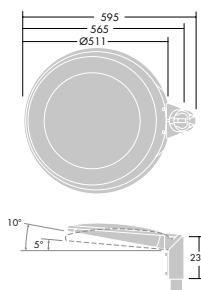

Dyana L

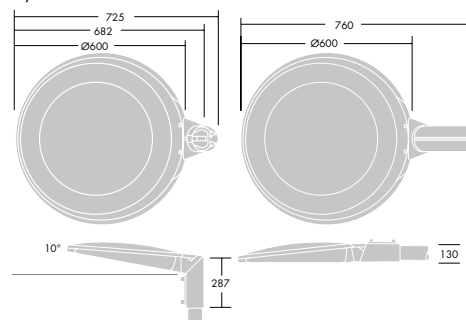

Material / Model

- Housing and column-top made from diecast aluminium, powder coated in THORN DARK GREY, structured (similar to DB 703 / AKZO 900)
- Tool-less access to the LED and equipment compartment
- Cover made from flat safety glass, clear

Accessories

- Adapter for column-top mounting for spigot size Ø 76 mm (Dyana L)
- Reduction piece for side-entry mounting for spigot size Ø 42 mm (Dyana L)
- Integration of various sensors and smart lighting components

Installation / Assembly

Dyana S

- Suitable for column-top mounting for optional spigot size Ø 76 mm or Ø 60 mm or for side-entry mounting for spigot size Ø 60 mm with an insertion depth of 100 mm
- Tilt angle with column-top mounting adjustable between 0° and +5°
- Tilt angle with side-entry mounting adjustable between 0° and -5°

Dyana L

- Suitable for column-top mounting for spigot size Ø 60 mm or for side-entry mounting for spigot size Ø 60 mm with an insertion depth of 100 mm
- Tilt angle with column-top mounting of +10°
- Tilt angle with side-entry mounting of 0°

Orus LED

Innovative street light for low installation heights and optimum glare control, thanks to the patented Flat Beam® technology.



Technical data

Rated luminous flux:

- Orus LED: 1 800–2 100 lm

Rated output:

- Orus LED: 27–40 W

Light colours:

- 4000 K

Service life:

- 80,000 hours @ Ta 25 °C L70/B10

Light distribution options:

- R optics for efficient illumination of the road surface
- S-optics with integrated additional reflector for additional visibility of pedestrians in the column area

IK10 IP66



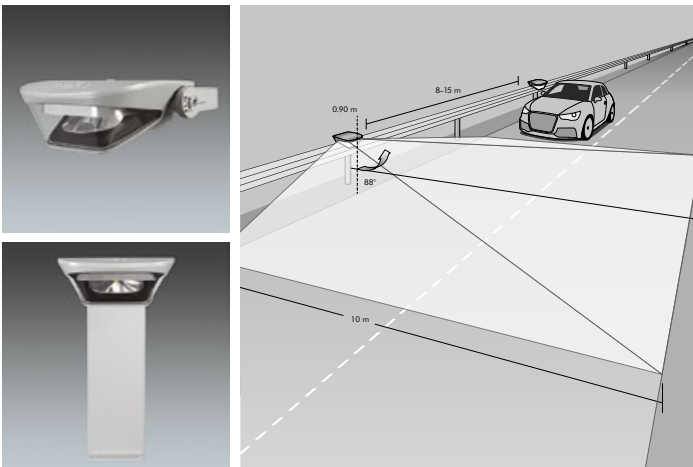

Orus LED with bracket mounting

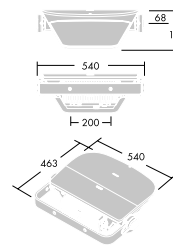

Orus LED with column base (bollard installation)

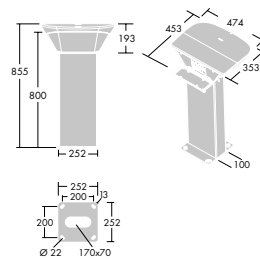

Flat Beam® Technology

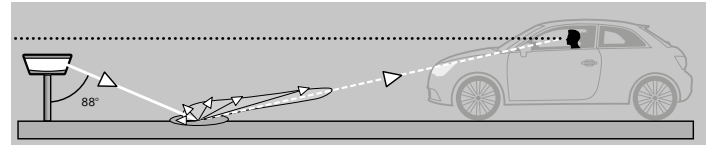

Material / Model

- Housing made from diecast aluminium, powder coated in THORN LIGHT GREY, structured (similar to RAL 9006 / AKZO 150)
- Cover made from extremely tough (2 x IK10/40 Joule) and UV stabilised polycarbonate, with special scratch-resistant anti-graffiti special coating
- Reflector with highly reflective aluminium coating
- Vandal-proof stainless steel screws, treated with Ecolubric®
- Optional mounting bracket for flexible wall or handrail mounting made from diecast aluminium, powder coated in THORN LIGHT GREY, structured (similar to RAL 9006 / AKZO 150)
- Optional column base for installation as bollard light made from 3 mm thick steel, powder coated in THORN LIGHT GREY, structured (similar to RAL 9006 / AKZO 150)

Installation / Assembly

- Orus LED is available for assembly using a mounting bracket or as a bollard light using a steel column base
- For optimum use of the Flat Beam® technology we recommend an installation height of 0.9 m above the road surface and a distance of approx. 1.5 m from the illuminated surface.
- Mounting bracket attached using 2 x M10 screws
- Mounting bracket can be swivelled by 180°
- Column base attached using welded-on flanged plate
- Access to equipment compartment via vandal-proof stainless steel screws
- Cable lead-in for cables with \varnothing 8 to 13 mm

R2L2

A versatile, efficient and future-oriented family of luminaires for all urban requirements.



Technical data

Rated luminous flux:

- R2L2 S: 1700–12,000 lm
- R2L2 M: 8400–30,000 lm

Rated output:

- R2L2 S: 15–103 W
- R2L2 M: 63–270 W

Light colours:

- 3000 K and 4000 K

Service life:

- 100,000 hours @ Ta 25 °C L90/B10

Light distribution options:

- 12 different THORN R-PEC
LED light distribution options





Material / Model

- Complete housing made from diecast aluminium, powder coated in THORN LIGHT GREY, structured (similar to RAL 9006 / AKZO 150)
- Tool-less access to equipment compartment via a stainless steel clip
- Cover made from flat safety glass, clear
- Screws made from stainless steel, treated with Ecolubric®

Accessories

- Anti-glare louvre for house and road side
- Reduction piece for side-entry mounting for column spigot \varnothing 34–42 mm
- Integration of various sensors and smart lighting components

R2L2 S

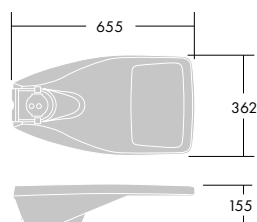

R2L2 M

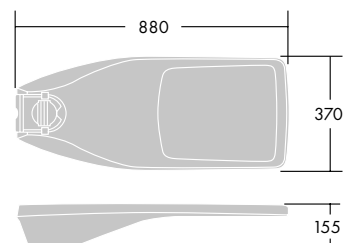

Installation / Assembly

- Installation takes place using a universal column adapter that is integrated in the housing for column-top mounting for spigot size \varnothing 60–76 mm or for side-entry mounting for spigot size \varnothing 48–60 mm
- The column adapter can be swivelled without tools for column-top or side-entry mounting
- Variable tilt setting in 5° steps from 0° to +10° with column-top mounting and from -15° to 0° with side-entry mounting

Thor

Developed for the requirements of a "Smart City", the Thor LED luminaire already has tomorrow's flexibility and intelligence today.



Technical data

Rated luminous flux:

- THOR: 6500–13,500 lm

Rated output:

- THOR: 50–110 W

Light colours:

- 3000 K and 4000 K

Service life:

- 100,000 hours @ Ta 25 °C L90/B10

Light distribution options:

- 12 different THORN R-PEC LED light distribution options





Material / Model

- Housing frame, top section and column-top made from diecast aluminium, powder coated in THORN DARK GREY, structured (similar to DB 703 / AKZO 900)
- The top section of the housing is also optionally available in an opal, UV-stabilised version made from polycarbonate (PC).
- Cover made from flat safety glass, clear
- Housing frame and top section also available for installation as an catenary luminaire

Accessories

- Adapter for column-top mounting for column spigot \varnothing 76 mm
- Reduction piece for side-entry mounting for column spigot \varnothing 3448 mm
- Adapter for different wire pendants
- Integration of various sensors and smart lighting components

Thor – Column-top

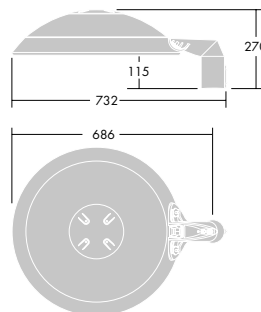

Thor – Side-entry

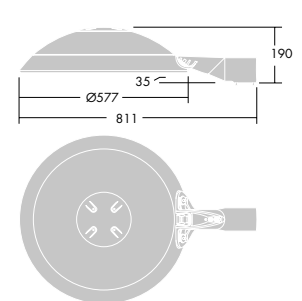

Installation / Assembly

- Suitable for column-top or side-entry mounting for spigot size \varnothing 60 mm with an insertion depth of 100 mm
- Tilt angle adjustable between 0° and $+10^\circ$ with column-top mounting and between 0° and -15° with side-entry mounting
- Delivery from factory pre-wired with 9 m cable
- Weight: max. 15.2 kg
- Catenary luminaire secured using the provided THORN wire pendants

Urba

Elegant, powerful family of LED luminaires for special requirements in urban areas.



Technical data

Rated luminous flux:

- Urba S: 1700–9000 lm
- Urba L: 6600–20,300 lm

Rated output:

- Urba S: 15–75 W
- Urba L: 51–180 W

Light colours:

- 3000 K and 4000 K

Service life:

- 100,000 hours @ Ta 25 °C L90/B10

Light distribution options:

- 12 different THORN R-PEC
LED light distribution options





Material / Model

- Housing and column-top made from diecast aluminium, powder coated in THORN BLACK, structured (similar to RAL 9005 / AKZO 200) or in THORN DARK GREY, structured (similar to DB 703 / AKZO 900)
- Tool-less access to equipment compartment
- Cover made from flat safety glass, clear
- Screws made from stainless steel, treated with Ecolubric®

Accessories

- Prismatic glass for Urba S, provides additional glare control and increases visual comfort
- Integration of various sensors and smart lighting components

Urba S – Post-Top/side-entry

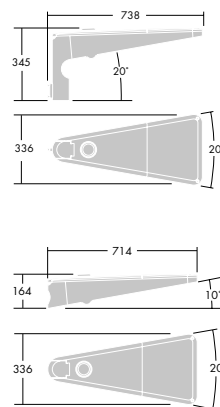

Urba L – Post-Top/side-entry

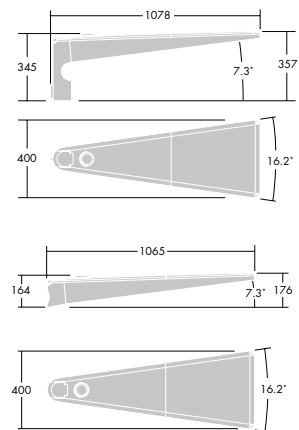

Installation / Assembly

- Suitable for column-top mounting for optional spigot size \varnothing 76 mm or \varnothing 60 mm with an insertion depth of 80 mm
- Alternatively suitable for side-entry mounting for spigot size \varnothing 60 mm with an insertion depth of 120 mm
- Tilt angle with side-entry mounting adjustable between 0° , -5° and -10°

Alumet Stage

Intelligent and multi-functional LED light column for square and pavement lighting, accentuation and for the integration of "Smart City" functions.



Technical data

Rated luminous flux:

- Alumet Stage: 800–4000 lm
(depending on the selected configuration)

Rated output:

- Alumet Stage: 17–84 W
(depending on the selected configuration)

Light colours:

- 3000 K and 5000 K
- Red, green, blue and amber

Service life:

- 35,000–50,000 hours @ Ta 25 °C L90/B10

Light distribution options:

- narrow or medium width light distribution



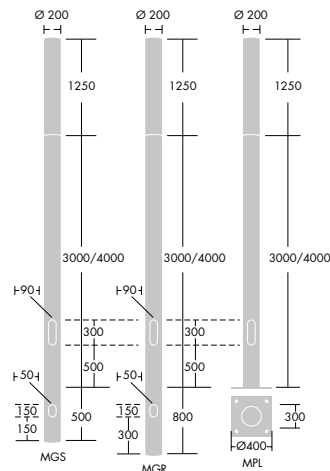
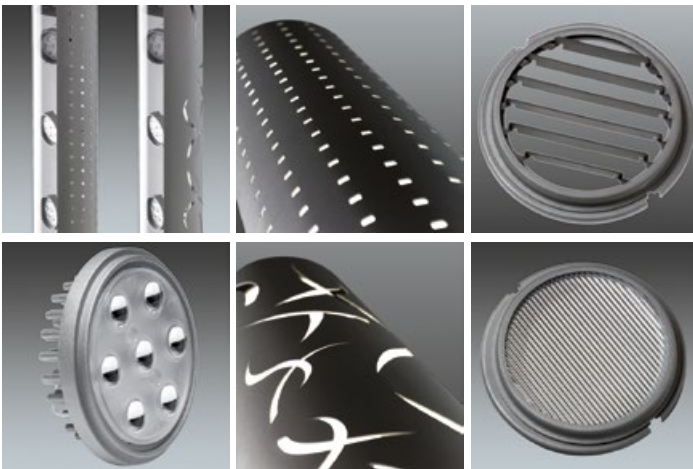

Material / Model

- Cover made from clear, UV-stabilised polycarbonate (PC) with special anti-graffiti coating
- Housing made from diecast aluminium, powder coated in THORN LIGHT GREY, structured (similar to RAL 9006 / AKZO 150)
- System column made from aluminium, powder coated in THORN LIGHT GRAY, structured (similar to RAL 9006 / AKZO 150)

Accessories

- Decorative glare protection (180° shading) made from aluminium in different laser-cut designs
- Vane louver for reducing side view
- Glass refractor for LED module for changing the light distribution to an asymmetrically wide beam optic
- Integration of various sensors and smart lighting components

Installation / Assembly

- Alumet Stage poles available in heights of 3.0 m or 4.0 m (other heights on request)
- Posts optionally with flange (MPL) or root mounting (MGR)
- Flanged plate 400 x 400 mm with 300 x 300 mm hole spacing for 18 x 400 mm screws (included in scope of delivery)
- Total height of light column (incl. 1250 mm long luminaire head) is 4.25 m or 5.25 m
- LED control gear elements integrated in luminaire head
- Luminaire head pre-wired in factory with 4.0 m luminaire cable

Alumet Control Direct

New intelligent column, with a clever mix of aesthetics, performance and comfort and for the integration of "Smart City" functions.



Technical data

Rated luminous flux:

- 2000–4200 lm

Light colours:

- 3000 K and 4000 K

Service life:

- 100,000 hours @ Ta 25 °C / B10L80

Optics:

- Revolution symmetric
- Asymmetric
- Asymmetric comfort

Control systems:

- Dimmable DALI
- Integrated motion detection

Options:

- Autonomous power reduction
- Integration of intelligent sensors



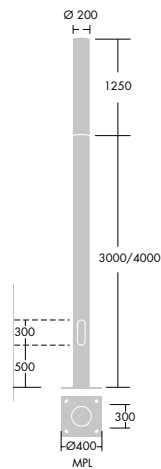
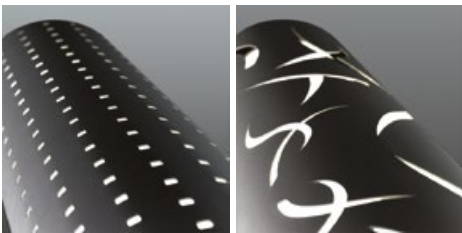

Material / Model

- Cover: die-cast aluminium, powder coated textured silver grey AKZO 150
- Diffuser: clear UV stabilised PC treated with anti-graffiti varnish
- Column: extruded aluminium, powder coated textured silver grey AKZO 150

Accessories

- Decorative 180° aluminium lampshields, square and arabesque, powder coated textured silver grey AKZO 150. Other versions available on request

Installation / Assembly

- Column of 3 or 4 m (without the head), Flanged plate 400 x 400 mm
- Including bolts (spacings 300 x 300 mm)
- Total height (with lit part of 1.25 m): 4.25 m or 5.25 m
- Pre-wired head with 4 m cable

Avenue D² LED

A slim and elegant LED luminaire with prismatic cover for comfortable lighting in inner-city areas.



Technical data

Rated luminous flux:

- Avenue D² LED: 1700–3500 lm

Rated output:

- Avenue D² LED: 21–41 W

Light colours:

- 3000 K and 4000 K

Service life:

- 100,000 hours @ Ta 25 °C L90/B10

Light distribution options:

- Symmetrical light distribution
- Wide-beam, asymmetrical street optics

IK08 IP66   CE

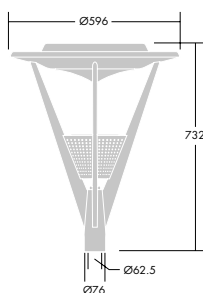
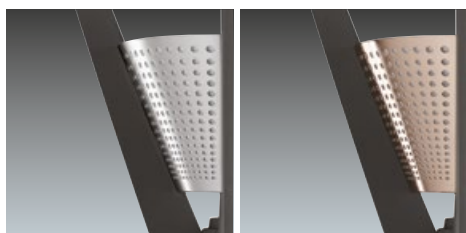

Material / Model

- Housing and struts made from diecast aluminium, powder coated in THORN DARK GREY, structured (similar to DB 703 / AKZO 900)
- Luminaire top made from aluminium
- Cover made from UV-stabilised polycarbonate (PC) with prism structure for glare reduction
- Decorative anti-glare shield available with copper or stainless steel look
- Integrated switch for enabling and disabling the autonomous power reduction
- Screws made from stainless steel

Accessories

- Adapter for column-top mounting for column spigot Ø 76 mm

Installation / Assembly

- Suitable for column-top mounting for spigot size Ø 60 mm with an insertion depth of 90 mm
- Access to LED and equipment compartment via 4 stainless steel screws in the luminaire top
- Luminaire pre-wired in factory with 4.0 m luminaire cable

Avenue F² LED

Timelessly elegant column-top luminaire for high-quality city lighting with particular focus on convenience.



Technical data

Rated luminous flux:

- Avenue F² LED: 2300–4000 lm

Rated output:

- Avenue F² LED: 21–41 W

Light colours:

- 3000 K and 4000 K

Service life:

- 100,000 hours @ Ta 25 °C L90/B10

Light distribution options:

- Symmetrical light distribution
- Wide-beam, asymmetrical street optics

IK08 IP66   CE

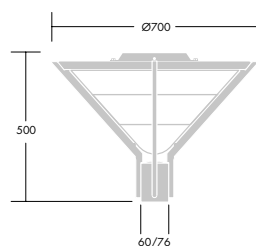

Material / Model

- Housing and struts made from diecast aluminium, powder coated in THORN DARK GREY, structured (similar to DB 703 / AKZO 900)
- Luminaire top made from aluminium
- Cover made from clear, UV-stabilised polycarbonate (PC)
- Additional prismatic ring for reducing glare
- Integrated switch for enabling and disabling the autonomous power reduction
- Screws made from stainless steel

Installation / Assembly

- Suitable for column-top mounting for optional spigot size Ø 60 mm or Ø 76 mm with an insertion depth of 75 mm
- Access to LED and equipment compartment via 3 stainless steel screws in the luminaire top
- Luminaire pre-wired in factory with 4.0 m luminaire cable

EP 145 LED

Classic luminaire design in historical style with the latest LED technology.



Technical data

Rated luminous flux:

- EP145 LED: 2800–6100 lm

Rated output:

- EP145 LED: 38–84 W

Light colours:

- 3000 K and 4000 K

Service life:

- 100,000 hours @ Ta 25 °C L90/B10

Light distribution options:

- 12 different THORN R-PEC LED light distribution options





EP145 LED – Post-Top

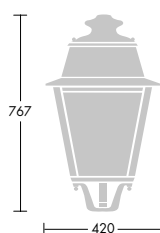

EP145 LED – Pendant

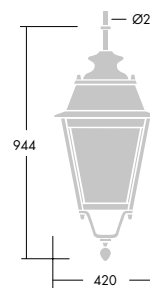

Material / Model

- Housing made from stainless steel, powder coated in THORN BLACK, structured (similar to RAL 9005 / AKZO 200) or from copper with anticorrosion coating
- Cover of LED module made from flat safety glass, clear
- Luminaire without inserted diffuser made from PMMA as standard

Accessories

- Luminaire diffuser made from PMMA (acrylic) in clear or pearl version
- Adapter for assembly on column spigot \varnothing 76 mm or \varnothing 60 mm
- Decorative system column and bracket for EP145 LED
- Cable reel and chain for assembly of the pendant

Installation / Assembly

- Housing available for assembly as column-top or pendant luminaire
- Post top mounting for optional spigot size \varnothing 76 mm or \varnothing 60 mm via special adapter or via \varnothing 27G thread with diecast or system column
- Pendant via special system bracket via \varnothing 27G thread or via cable reel for chain attachment (as accessory)

FleXity

Compact, modern and economical LED luminaire for many applications in urban areas.



Technical data

Rated luminous flux:

- FleXity: 1600–6900 lm

Rated output:

- FleXity: 20–83 W

Light colours:

- 3000 K and 4000 K

Service life:

- 100,000 hours @ Ta 25 °C L90/B10

Light distribution options:

- 12 different THORN R-PEC
LED light distribution options



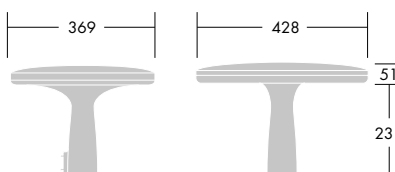

Material / Model

- Complete housing made from diecast aluminium, powder coated in THORN DARK GREY, structured (similar to DB 703 / AKZO 900) or in THORN LIGHT GREY, structured (similar to RAL 9006 / AKZO 150)
- Cover made from UV-stabilised and tough polycarbonate (PC) in clear or opal version

Accessories

- Integration of various sensors and smart lighting components

Installation / Assembly

- Suitable for column-top mounting for optional spigot size \varnothing 60 mm or \varnothing 76 mm with an insertion depth of 75 mm
- Access to LED and equipment compartment via 4 stainless steel screws
- Luminaire pre-wired in factory with 5.0 m luminaire cable

Gamma LED

A compact and versatile column-top luminaire for many different applications in urban environments.



Technical data

Rated luminous flux:

- Gamma LED: 2600–5500 lm

Rated output:

- Gamma LED: 28–54 W

Light colours:

- 3000 K and 4000 K

Service life:

- 100,000 hours @ Ta 25 °C L90/B10

Light distribution options:

- Different THORN R-PEC
LED light distribution options



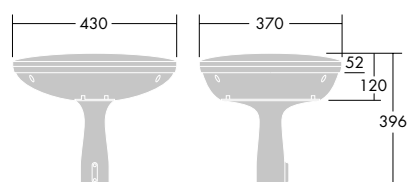
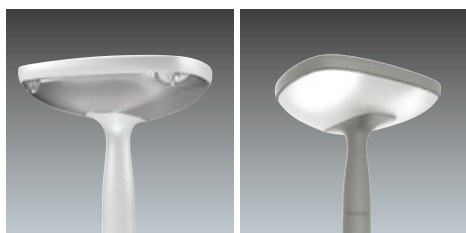

Material / Model

- Complete housing made from diecast aluminium, powder coated in THORN LIGHT GREY, structured (similar to RAL 9006 / AKZO 150) or THORN DARK GREY, structured (similar to DB 703 / AKZO 900)
- Cover made from UV-stabilised and tough polycarbonate (PC) in satin-finish version

Accessories

- Integration of various sensors and smart lighting components

Installation / Assembly

- Suitable for column-top mounting for optional spigot size \varnothing 60 mm or \varnothing 76 mm with an insertion depth of 75 mm
- Access to LED and equipment compartment via 4 stainless steel screws
- Luminaire pre-wired in factory with 5.0 m luminaire cable

Legend

Modern interpretation of a traditional luminaire design, with the latest LED technology.



Technical data

Rated luminous flux:

- Legend: 3500–5000 lm

Rated output:

- Legend: 58–840 W

Light colours:

- 3000 K and 4000 K

Service life:

- 100,000 hours @ Ta 25 °C L90/B10

Light distribution options:

- 12 different THORN R-PEC
LED light distribution options

IK08 IP66   CE



Material / Model

- Complete housing made from diecast aluminium, powder coated in THORN DARK GREY, structured (similar to DB 703 / AKZO 900)
- Cover made from flat safety glass, clear
- Optionally available indirect reflector insert for discreet overhead light

Legend – PostTop

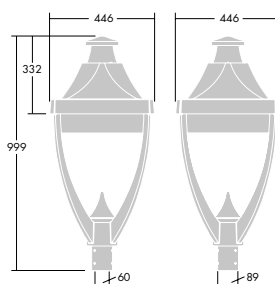

Legend – Pendant

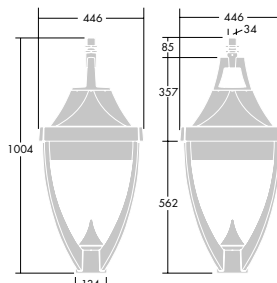

Installation / Assembly

- Housing available for assembly as column-top or pendant luminaire
- Suitable for column-top mounting for spigot size \varnothing 60 mm with an insertion depth of 100 mm
- Pendant via special system bracket via \varnothing 34G thread

Plurio LED

Decorative LED luminaire with outstanding light quality for excellent glare and scattered light limitation.



Technical data

Rated luminous flux:

- Plurio LED: 1780–4740 lm

Rated output:

- Plurio LED: 20–60 W

Light colours:

- 3000 K and 4000 K

Service life:

- 100,000 hours @ Ta 25 °C L90/B10

Light distribution options:

- Symmetrical light distribution
- Wide-beam, asymmetrical street optics

IK08 IP65   CE

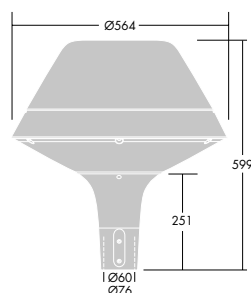

Material / Model

- Mast top made from diecast aluminium, powder coated in THORN LIGHT GREY, structured (similar to RAL 9006 / AKZO 150)
- Luminaire top made from aluminium, powder coated in THORN LIGHT GRAY, structured (similar to RAL 9006 / AKZO 150)
- Cover made from UV-stabilised polycarbonate (PC) with prism structure for glare reduction
- Internal reflector in white, highly reflective
- Integrated switch for enabling and disabling the autonomous power reduction
- Screws made from stainless steel

Installation / Assembly

- Suitable for column-top mounting for optional spigot size \varnothing 60 mm with insertion depth of 75 mm or spigot size \varnothing 76 mm with an insertion depth of 100 mm
- Access to LED and equipment compartment via 3 stainless steel screws
- Luminaire pre-wired in factory with 4.0 m luminaire cable

Urba Deco

Versatile family of luminaires with modern design for any requirements in urban areas.



Technical data

Rated luminous flux:

- Urba Deco: 2150–9200 lm

Rated output:

- Deco: 20–72 W

Light colours:

- 3000 K and 4000 K

Service life:

- 100,000 hours @ Ta 25 °C L90/B10

Light distribution options:

- 12 different THORN R-PEC
LED light distribution options

IK10

IP66



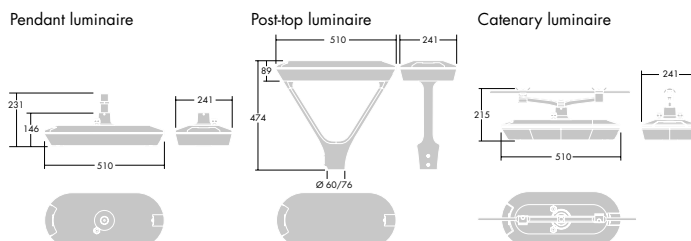

Material / Model

- Urba Deco available in three versions for installation as column-top, catenary and pendant luminaire
- Housing and column-top mounting made from diecast aluminium, powder coated in THORN BLACK, structured (similar to DB 9005 / AKZO 200)
- Tool-less access to equipment compartment (overhead cable and pendant luminaire, secured with a single screw)
- Cover made from flat safety glass, clear
- Inner cover of luminaire arms with column-top luminaire made from white, UV-resistant and weather-resistant ASA plastic
- Wire pendant of the catenary cable luminaire made from steel, hot-dip galvanised and power coated in the same colour as the luminaire
- Screws made from stainless steel, treated with Ecolubric®

Installation / Assembly

- Post top luminaire suitable for assembly for spigot size $\varnothing 60$ mm with insertion depth of 80 mm or spigot size $\varnothing 76$ mm with an insertion depth of 100 mm
- Post-top luminaire pre-wired in the factory with 6.0 m cable
- Installation of catenary luminaire via the supplied THORN wire pendant
- THORN wire pendant can be rotated by 360° and tilted by $\pm 15^\circ$ on site
- Pendant luminaire suitable for installation using a special system bracket with $\varnothing 34G$ thread



Variant "T"

"L" variant

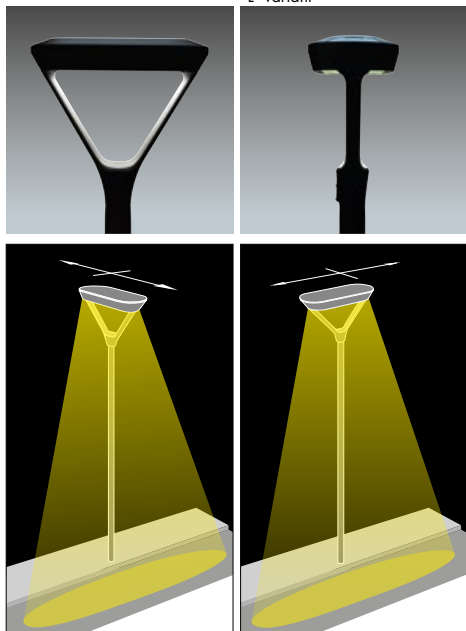

Select variant "T" to install the Urba Deco at right angles to the street, or the "L" variant to install the Urba Deco parallel to the road.

Accessories

- Prismatic glass for additional glare control and to increase viewing comfort
- Inner cover of luminaire arms available in black with column-top luminaire (light emission 0 %)
- Wall and column bracket in different versions for column-top and pendant luminaires
- Loop-through-wiring for catenary and pendant luminaires
- Integration of various sensors and smart lighting components



Thor LED bollard

Elegant bollard luminaire in different designs with intelligent control options.

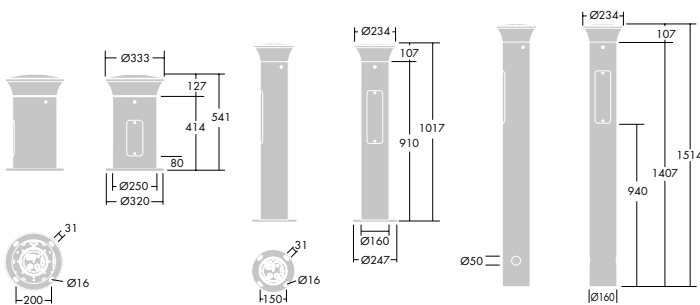

Variant "W" flange mounting

Variant "S" flange mounting

Variant "S" root mounting

Material / Model

- Complete housing made from diecast aluminium, powder coated in THORN DARK GREY, structured (similar to DB 703 / AKZO 900)
- Available in housing variants Wide ("W") and Slim ("S")
- Cover made from extremely tough (up to 2 x IK10/40 Joules with variant "W") and UV-stabilised polycarbonate

Installation / Assembly

- Variant "W" suitable for flange mounting with 4 x anchor bolts M14, hole spacing 200 mm
- Variant "S" suitable for flange mounting with 4 x anchor bolts M14 and hole spacing of 150 mm or for root mounting
- Top section of luminaire pre-wired in the factory and secured to luminaire housing with vandal-proof screws

Accessories

- Decorative LED continuous row in red, green or blue (can be selected on site using an integrated rotary switch)
- Presence detection via an integrated HF sensor with optional radio control with master and slave function (networking of up to 6 Thor LED bollards)

Technical data

Rated luminous flux:

- Thor LED bollard: 570–1200 lm

Rated output:

- Thor LED bollard: 11–13 W

Light colours:

- 3000 K and 4000 K
- Optional LED strip, adjustable in red, green or blue

Service life:

- 100,000 hours @ Ta 25 °C L90/B10

Light distribution options:

- Symmetrical light distribution
- Asymmetrical light distribution



Altis Area

High-performance LED floodlight for illuminating large areas.

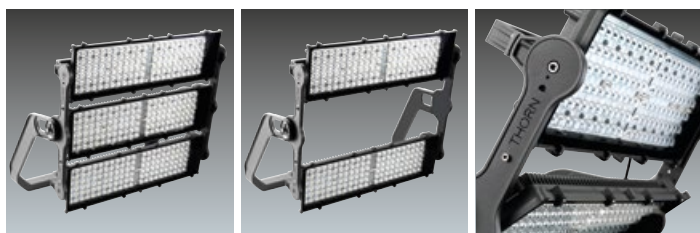

Material / Model

- Housing, frame and mounting bracket made from diecast aluminium, powder coated in THORN DARK GREY, structured (similar to DB 703 / AKZO 900)
- Cover made from flat safety glass, clear
- Screws made from stainless steel

Installation / Assembly

- Suitable for direct attachment via the mounting bracket through a hole with \varnothing 22 mm and/or two drill holes with \varnothing 15 mm
- LED modules are pre-wired in the factory 1.0 m cable (with plug)
- The electrical connection is made directly via a multi-wire cable to the ballast.
- Ballast available with degree of protection IP21 for assembly in the column or a switch cabinet and with degree of protection IP65 for fitting to the luminaire housing or externally to the column.
- LED modules can be swivelled separately on site for optimised light distribution and uniformity
- Weight: max. 28.0 kg

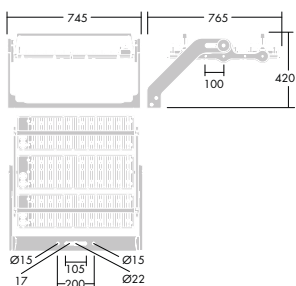

Technical data

Rated luminous flux:

- Up to 120,000 lm

Light colours:

- 4000 K with CRI >70

Service life:

- 100,000 hours @ Ta 25 °C L80/B10

Light distribution options:

- 4 asymmetrical LED light distribution options



Altis Sport

LED floodlight for illuminating sports facilities



Material / Model

- Housing, frame and mounting bracket made from diecast aluminium, powder coated in THORN DARK GREY, structured (similar to DB 703 / AKZO 900)
- Cover made from flat safety glass, clear
- Prepared for integration in DMX and DALI control systems
- TLCI (Television Lighting Consistency Index) of 94
- Screws made from stainless steel

Installation / Assembly

- Suitable for direct attachment via the mounting bracket through a hole with \varnothing 22 mm and/or two drill holes with \varnothing 15 mm
- LED modules are pre-wired in the factory 1.0 m cable (with plug)
- The electrical connection is made directly via a multi-wire cable to the ballast
- Ballast available with degree of protection IP21 for assembly in the column or a switch cabinet and with degree of protection IP65 for fitting to the luminaire housing or externally to the column
- LED modules can be swivelled separately on site for optimised light distribution and uniformity
- Weight: max. 28.0 kg

Accessories

- Aiming device for exact alignment of the LED modules

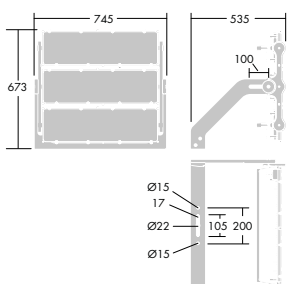

Technical data

Rated luminous flux:

- Up to 140,000 lm

Light colours:

- 4000 K with CRI >70
- 5700 K with CRI >90 (TLCI 94)

Service life:

- 40,000 hours @ Ta 25 °C L80/B10

Light distribution options:

- 5 different LED light distribution options for lighting sports facilities



Areaflood Pro

High-quality family of floodlights with top class optical performance and highly-efficient LED technology



Technical data

Rated luminous flux:

- Areaflood Pro S: 3400–9500 lm
- Areaflood Pro M: 6800–18,900 lm
- Areaflood Pro L: 14,000–37,100 lm

Rated output:

- Areaflood Pro S: 27–77 W
- Areaflood Pro M: 51–153 W
- Areaflood Pro L: 100–307 W

Light colours:

- 3000 K and 4000 K

Service life:

- 100,000 hours @ Ta 25 °C L90/B10

Light distribution options:

- Different THORN R-PEC
LED light distribution options



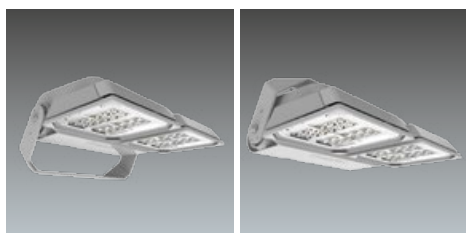

Areaflood Pro – S

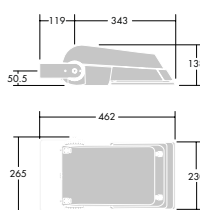

Areaflood Pro – M

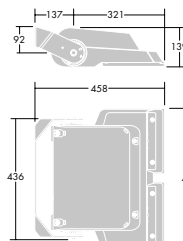

Areaflood Pro – L

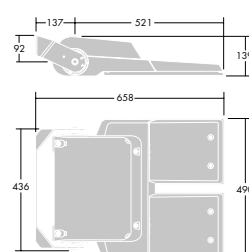

Material / Model

- Complete housing made from diecast aluminium, powder coated in THORN LIGHT GREY (similar to RAL 9006)
- Cover made from flat safety glass, clear
- Screws made from stainless steel

Accessories

- Adapter for column mounting for spigot size \varnothing 76 mm or \varnothing 60 mm
- special coating for swimming pools or salt water atmospheres
- Integration of various sensors and smart lighting components

Installation / Assembly

- Suitable for direct attachment via the mounting bracket through a Drill hole with \varnothing 22 mm and/or two drill holes with \varnothing 12 mm (with design "S") or \varnothing 15 mm (with design "M" & "L")
- Mounting bracket can be swivelled 10° steps by $\pm 250^\circ$ for ceiling or wall mounting

Control options

By using intelligent ballast, we can provide a multitude of different dimming and control options, whereby the light can be controlled in accordance with requirements, individually and precisely in order to save energy and improve the CO₂ balance.

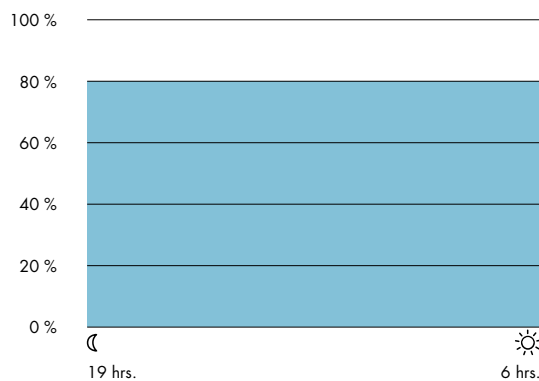

ALO – Adjustable Light Output

This function can be used to set the rated luminous flux of the luminaire to exactly the value that is needed. Of course, additional energy can be saved from this value by using other dimming options such as BPS or LRT. The programming can be carried out in the factory if required or on site using a programming device.

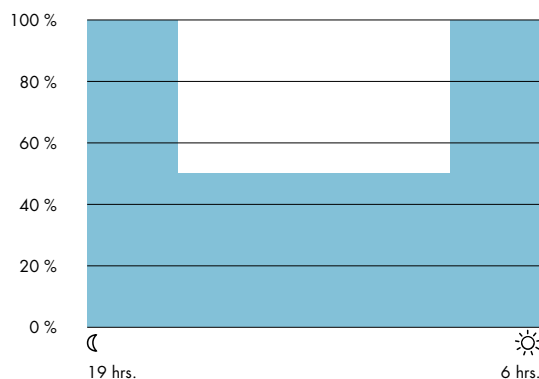

LRT – Light Reduction Twin-Phase

LRT, which is also known as half-night switching or step switching, is used in installations in which a special control line (switched phase) is available in addition to the power line. The electronic ballast detects the switching off of this control phase and reduces the light output of the luminaire to a programmed value (usually 50 % of the light current). The starting and reduction values of the luminaire can be set individually using the ALO function.

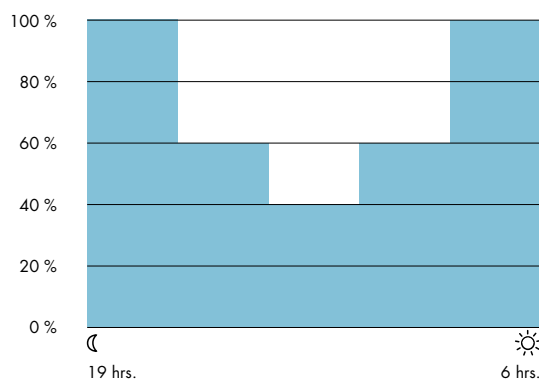

BP – autonomous light reduction (Bi-Power)

The BP (Bi-Power) function is often referred to as astro-dimming. This function does not require any external controller wiring in the network for operation, which means that bi-power is suitable for any kind of new building or modernisation. With bi-power the ballast of the luminaire executed a pre-set dimming profile, which has already been programmed into the luminaire in the factory. The electronics creates an artificial "midnight" using the on and off switching times for the previous nights using a time recording facility integrated in the ballast. From this midnight, the luminaire reduces the power autonomously using the programmed dimming profile (as standard over 8 hours to 50 % output - 3 hours before and 5 hours after the calculated "midnight"). If required, this dimming profile can be adapted in the times and outputs.

THORN R-PEC®

LED light distribution options for the highest efficiency

The THORN R-PEC® LED light distribution options are based on a multi-layer lens system and provide adequate light distribution options for any requirements in street and outdoor lighting.

Optic designation	Use and street type	Recommended lighting classes	Glare control class at 0° tilt
RC	Road, comfort	ME classes	G4
NR	Narrow road	ME classes	G3
WR	Wide road	ME classes	G4
EWR	Extra-wide road	CE & ME classes	G3
RWET	Road, wet	ME-classes (wet)	G6
IVS	Pedestrian crossing	Pedestrian crossing	-
SC	Side road, comfort	S & ME classes	G6
WS	Wide side road	S classes	G0
WSC	Wide side road, comfort	S classes	G3
EWS	Extra-wide side road	S classes	G0
EWSC	Extra-wide side road, comfort	S classes	G3
PWC	Wide pathway, comfort	S classes	G6

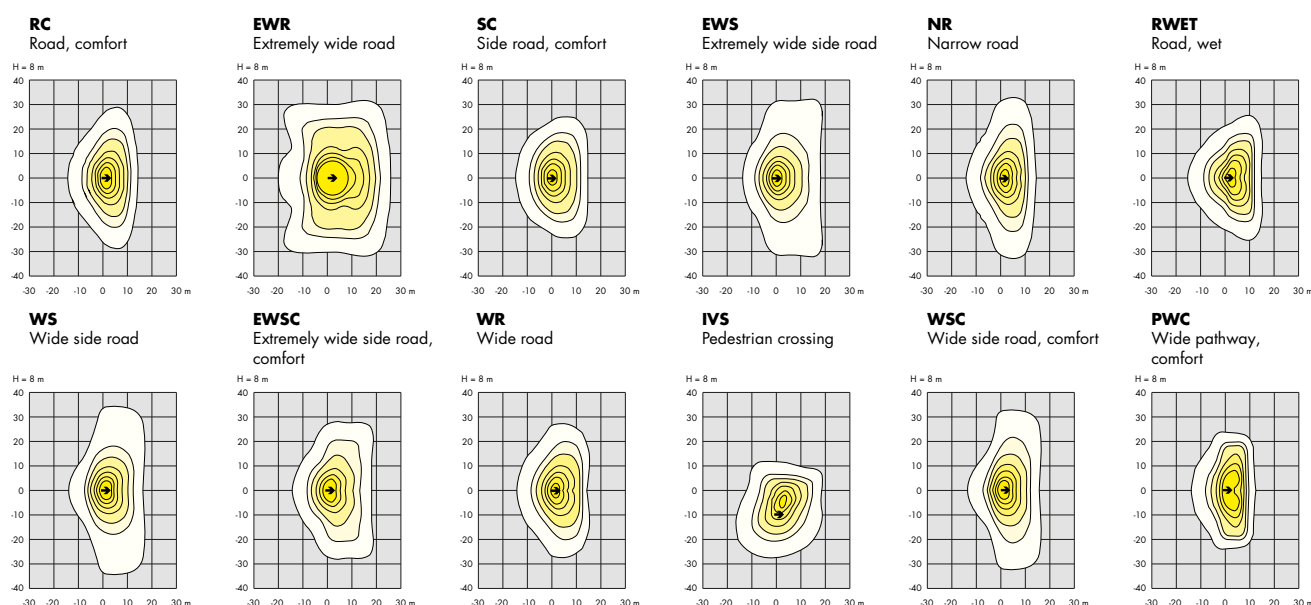

1.35							
1.20	RC	NR	PWC			RWET	
1.00							IVS
0.85	SC	WR		WS			
0.70			WSC		EWR		
0.60							
0.45			EWSC	EWS			
Factor = $\frac{\text{Light point height}}{\text{Road width}}$	ME comfort	ME	S comfort	S	CE class	MEW	Pedestrian crossing
	Dry conditions					Wet conditions	



Divide light point height by area to be illuminated to obtain a rough pre-selection of the THORN R-PEC LED optic with the result!

Example:
 Lighting class: ME 4b
 Light point height: 10.0 m
 Road width: 8.5 m
 Pavement width: 2.0 m respectively
 Calculation: $10 / 12.5 = 0.8$
 Recommendation: R-PEC optic SC or WR

Configuration instructions

Example of a THORN item designation

CQ	L	48 L	35	740	NR	LRT	CL2	CLO	M76	D8M	ANT
											ANT THORN dark grey, structured (similar to DB 703 / AKZO 900) GY THORN light grey, structured (similar to RAL 9006 / AKZO 150) LGY THORN light grey (similar to RAL 9006) BK THORN black, structured (similar to RAL 9005 / AKZO 200) RXXXX Painted in RAL of choice BDM Special coating for salt water atmosphere
										D6M 6 m pre-cabled D8M 8 m pre-cabled D10M 10 m pre-cabled DXXM XX m pre-cabled	
									M42 Post flange for column spigot Ø 42 mm M60 Post flange for column spigot Ø 60 mm M76 Post flange for column spigot Ø 76 mm MLE Side-entry mounting for column spigot Ø 60 mm MTP60 Post top mounting for column spigot Ø 60 mm MTP76 Post top mounting for column spigot Ø 76 mm		
								ADC Automatic power interruption when housing opened ALO Fixed setting to individual light output in the factory CLO Constant light output PN Nema holder PM With integrated mini-cell			
							CL1 Protection class I CL2 Protection class II				
						BP Autonomous power reduction over 8 hours to 50 % light output (programmed) BPS Autonomous power reduction over 8 hours to 50 % light output (can be disabled using a terminal) BPSW Autonomous power reduction over 8 hours to 50 % light output (can be disabled using a switch) BPX-XX Autonomous power reduction over X hours to XX % light output (programmed in factory)					
						LRT Power reduction to 50 % of light output via 230 V control phase RF Radio control HFX Controllable via DALI interface					
					NR Narrow road WR Wide road RC Road, comfort EWR Extremely wide road RWET Road, wet IVS Pedestrian crossing SC Side road, comfort WS Wide side road WSC Wide side road, comfort EWS Extremely wide side road EWSC Extremely wide side road, comfort PWC Wide pathway, comfort xxx-S Above-mentioned LED optics, symmetrically arranged xxx-A Above-mentioned LED optics, asymmetrically arranged A/S4 Asymmetric light distribution with 40° beam angle A/S5 Asymmetric light distribution with 50° beam angle A/S6 Asymmetric light distribution with 60° beam angle R/S Symmetrical light distribution NST Narrow-beam, asymmetrical street optics WST Wide-beam, asymmetrical street optics						
				730 3000 K CRI>70 740 4000 K CRI>70 757 5700 K CRI>70 957 5700 K CRI>90 XXX XXX – individual light colour & colour rendering index							
			25 250 mA 35 350 mA 50 500 mA 70 700 mA 90 900 mA 105 1050 mA XX XX – preset to XX mA in the factory								
		1 L 1 LED 10 L 10 LEDs 12 L 12 LEDs 18 L 18 LEDs 24 L 24 LEDs 36 L 36 LEDs 48 L 48 LEDs 60 L 60 LEDs 72 L 72 LEDs 84 L 84 LEDs 96 L 96 LEDs 108 L 108 LEDs 120 L 120 LEDs 132 L 132 LEDs 144 L 144 LEDs 264 L 264 LEDs 396 L 396 LEDs									
	S Small design M Medium design L Large design										

Luminaire family, e.g. CiviTEQ

Note concerning configuration instructions:

This guideline should give you a brief overview of the configuration options of the THORN ED luminaires. You can configure your desired product from the options and versions which are listed.

However, please note that not all of the variants listed here are available as standard and cannot be combined with every luminaire. Please contact your THORN contact partner if you have any further questions about your own configuration.



North + West + Central Africa

Thorn - Zumtobel Group
156 Boulevard Haussmann
75379 Paris Cedex 08, France
T+33 1 49 53 62 10
F+33 1 49 53 62 40
info.paris@thornlighting.com
www.thornlighting.fr

South + East Africa

Thorn Lighting
ZG Lighting (UK) Limited
Durhamgate, Spennymoor,
County Durham, DL16 6HL
Main Switchboard
United Kingdom
T+44 91 301 3062
marketing.mena@zumtobelgroup.com
www.thornlighting.com

Qatar

Thorn Lighting WLL
Zumtobel Lighting GmbH (Branch)
Abdul Jaleel Business Centre,
Office No. 304, Najma Airport road
P.O.Box: 6026
Doha, Qatar
T+974 4 432 1445
info.qa@zumtobelgroup.com
www.thornlighting.ae

United Arab Emirates - Dubai

Thorn Gulf
4B Street, Al Quoz industrial area 1,
P.O.Box: 22672, Dubai,
United Arab Emirates
T+971 4 340 0909
info.ae@zumtobelgroup.com
www.thornlighting.ae

Middle East

Zumtobel Lighting GmbH
4B Street, Al Quoz industrial area 1,
P.O.Box: 22672,
Dubai, United Arab Emirates
T+971 4 340 0909
info.ae@zumtobelgroup.com
www.thornlighting.ae

Kuwait

Thorn Lighting c/o Salem Al
Nisf General Building Contracting
Co WLL
PO Box 871 Safat
13009 Safat, Kuwait
T+965 9 293 7801
marketing.mena@zumtobelgroup.com
www.thornlighting.ae

Oman

Thorn Lighting c/o Bahwan Building
Material LLC
P.O.Box: 169 Muscat
100 Oman
T+968 9 293 7801
marketing.mena@zumtobelgroup.com
www.thornlighting.ae

India

Thorn Lighting India Pvt. Ltd.
410, Atlanta Estates
Goregaon East
Mumbai, 400063
T+91 (22) 2927 0456
info.in@zumtobelgroup.com
www.thornlighting.ae

Kingdom of Saudi Arabia

Zumtobel Lighting Saudi Arabia Ltd.
Prince Sultan St., Al Murjanah Tower
Bldg. No. 8125, 2nd Floor, Office 204
P.O.Box 11911 Jeddah, 21463
Kingdom of Saudi Arabia
T+966 12 691 3707
F+966 2 639 0232
info.sa@zumtobelgroup.com
www.thornlighting.ae

Site Internet:
www.thornlighting.com

 facebook.com/ThornLighting

 @thornlighting

 linkedin.com/company/thorn-lighting

 youtube.com/thornlightingpeople



5 Year Warranty

As a globally leading luminaire manufacturer, Thorn Lighting provides a five-year warranty for its complete product range within all European Countries.

www.thornlighting.com/warranty

Thorn Lighting is constantly developing and improving its products. All descriptions, illustrations, drawings and specifications in this publication present only general particulars and shall not form part of any contract. The right is reserved to change specifications without prior notification or public announcement. All goods supplied by the company are supplied subject to the company's General Conditions of Sale, a copy of which is available on request. All measurements are in millimetres and weights in kilograms unless otherwise stated.

Publication Nr. 96644275, Publication Date: 09/17



www.thornlighting.com

THORN